

GROUP 31

WHEEL AND TIRE





CONTENTS

WHEEL AND TIRE DIAGNOSIS	31-2	WHEEL AND TIRE	31-6
DIAGNOSIS	31-2	INSTALLATION SERVICE POINT	31-6
WHEEL BALANCE ACCURACY	31-3	SPECIFICATIONS	31-7
ON-VEHICLE SERVICE	31-6	FASTENER TIGHTENING	
TIRE INFLATION PRESSURE CHECK	31-6	SPECIFICATION	31-7
TIRE WEAR CHECK	31-6	GENERAL SPECIFICATIONS	31-7
WHEEL RUNOUT CHECK	31-6	SERVICE SPECIFICATIONS	31-7

WHEEL AND TIRE DIAGNOSIS

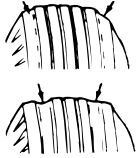
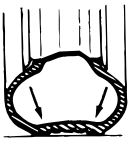
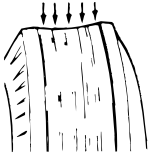
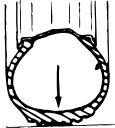
DIAGNOSIS

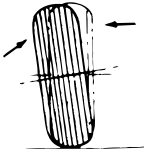
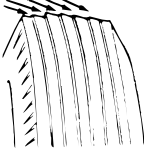
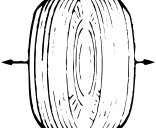
M1311000700330

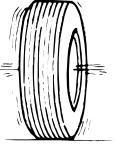
SYMPTOM		PROBABLE CAUSE		REMEDY	REFERENCE PAGE
Rapid wear at shoulders	 ACX00923AB	Under-inflation or lack of rotation	 ACX00924AE	Adjust the tire pressure.	For tire inflation pressure, refer to the label on the driver's side center pillar.
Rapid wear at center	 ACX00925AE	Over-inflation or lack of rotation	 ACX00926AE		
Cracked treads	 ACX00927AB	Under-inflation		Adjust the tire pressure.	For tire inflation pressure, refer to the label on the driver's side center pillar.
Wear on one side	 ACX00928AB	Excessive camber	 ACX00929AE	Check the camber.	Refer to GROUP 33A, On-vehicle service – Front wheel alignment check and adjustment P.33A-7 .
Feathered edge	 ACX00930AB	Incorrect toe-in	 ACX00931AE	Adjust the toe-in.	
Bald spots	 ACX00932AB	Unbalanced wheel	 ACX00933AB	Balance the wheels.	—

SYMPTOM		PROBABLE CAUSE	REMEDY	REFERENCE PAGE
Scalloped wear	 <p style="text-align: center;">ACX00934</p>	Lack of rotation of tires or worn or out-of-alignment suspension	Rotate the tires, check the front suspension alignment.	Refer to GROUP 33A, On-vehicle service – Front wheel alignment check and adjustment P.33A-7 .

WHEEL BALANCE ACCURACY

M1311001700203

PURPOSE

This section contains tips and procedures for achieving accurate wheel balance. Steering wheel vibration and/or body shake can result if any of these procedures are not carefully observed.

1. Wheels and tires must be properly mounted on a balancer in order to achieve correct balance. Centering the wheel on the shaft of the balancer is essential for proper mounting.
2. Off-the-car wheel balancers must be calibrated periodically to ensure good balancing results. An inaccurately calibrated balancer could cause unnecessary replacement of tires, shocks, suspension components, or steering components.

Check your balancer's calibration approximately every 100 balances. Your wheel balancer's instruction manual should include calibration procedures. If the calibration procedures specifically for your balancer are missing, use the generic steps in this section for zero calibration, static balance, and dynamic balance checks. The wheel balancer calibration checks are also described in the flowchart (Refer to [P.31-5](#)).

PROCEDURE <Balancing Tips>

1. Confirm that the balancer's cone and the wheel mounting cone are undamaged and free of dirt and rust.
2. On this vehicle, the wheel's center hole on the hub side has a chamfered edge. Use a back-mounting cone on your wheel balancer to center the wheel on the balancer shaft.
3. Install a wheel mounting cone. The appropriate size cone for this vehicle is 67.0 mm (2.64 inches).
4. Before balancing the wheel, remove any wheel weights from both sides. Also check both sides for any damage.
5. When installing wheel weights, hammer them at a straight (not diagonal) angle.

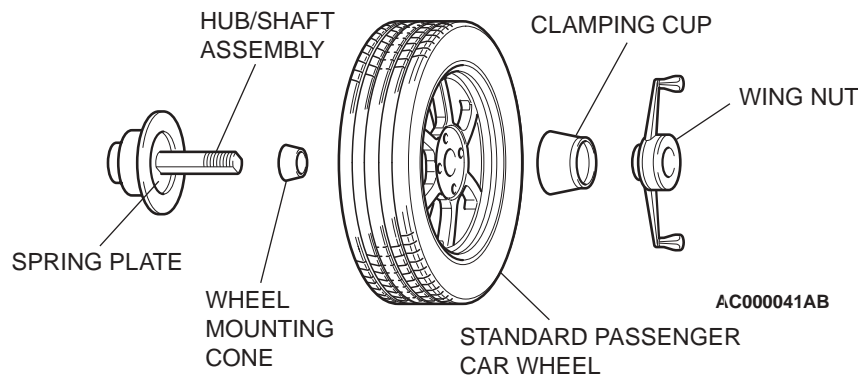

<Confirming Proper Balance>

1. After balancing the wheel, loosen the wing nut and turn the wheel 180 degree angle against the balancer's hub. Then re-tighten the wing nut and check the balance again. Repeat wheel balance if necessary.

<Wheel Balancer Calibration Checks>

1. Mount an undamaged original-equipment alloy rim and tire assembly (wheel) onto your off-the-car wheel balancer. Balance the wheel.
2. <<Zero Calibration Check>>
Loosen the balancer wing nut, rotate the wheel a half-turn (180 degree angle), and retighten the nut. Recheck the balance.
 - If the imbalance is 5 g (0.18 ounce) or less, the zero calibration is OK. Rebalance the wheel, then go to Step 4 to check static balance.
 - If the imbalance is more than 5 g (0.18 ounce), go to Step 3.
3. Loosen the balancer wing nut, rotate the wheel 1/4 turn (90 degree angle), and retighten the nut. Recheck the wheel balance.
 - If the imbalance is 5 g (0.18 ounce) or less, the wheel may not be centered on the balancer, or the balancing cones, the cup, and/or wing nut are damaged, dirty, or inappropriate for the wheel. You may need to refer to the balancer manufacturer's instructions to verify the correct attachments. After making the necessary corrections, recheck the wheel balance. If OK, then go to Step 4.
 - If the imbalance is more than 5 g (0.18 ounce), the balancer requires calibration. Contact the balancer manufacturer for calibration by their repair representative.

2. Turn the wheel again 180 degree angle against the balancer's hub. If the wheel becomes out-of-balance each time it is turned against the balancer's hub, the wheel balancer may require calibration.

4. <<Static Balance Check>>

Attach a 5-g (0.18-ounce) weight to the outer rim. Recheck the balancer. The balancer should detect 5 ± 2 g (0.18 ± 0.06 ounce) of imbalance 170 to 190 degree angle away from the 5-g (0.18-ounce) weight.

- If the imbalance is within specification, the static balance calibration is correct. Go to Step 5 to check the dynamic balance.
- If the imbalance is out of specification, the balancer requires calibration. Contact the balancer manufacturer for calibration by their repair representative.

5. <<Dynamic Balance Check>>

Attach a 5-g (0.18-ounce) weight to the inner rim at 180 degree angle opposite the 5-g (0.18-ounce) weight that was added in Step 4. Recheck the balance. The balancer should detect 5 ± 2 g (0.18 ± 0.06 ounce) of imbalance 170 to 190 degree angle away from both the inner and outer 5-g (0.18-ounce) weights.

- If the imbalance is within specification, the dynamic balance calibration is correct. The balancer calibration checks are complete.
- If the imbalance is out of specification, the balancer requires calibration. Contact the balancer manufacturer for calibration by their repair representative.

WHEEL BALANCER CALIBRATION CHECKING FLOW CHART

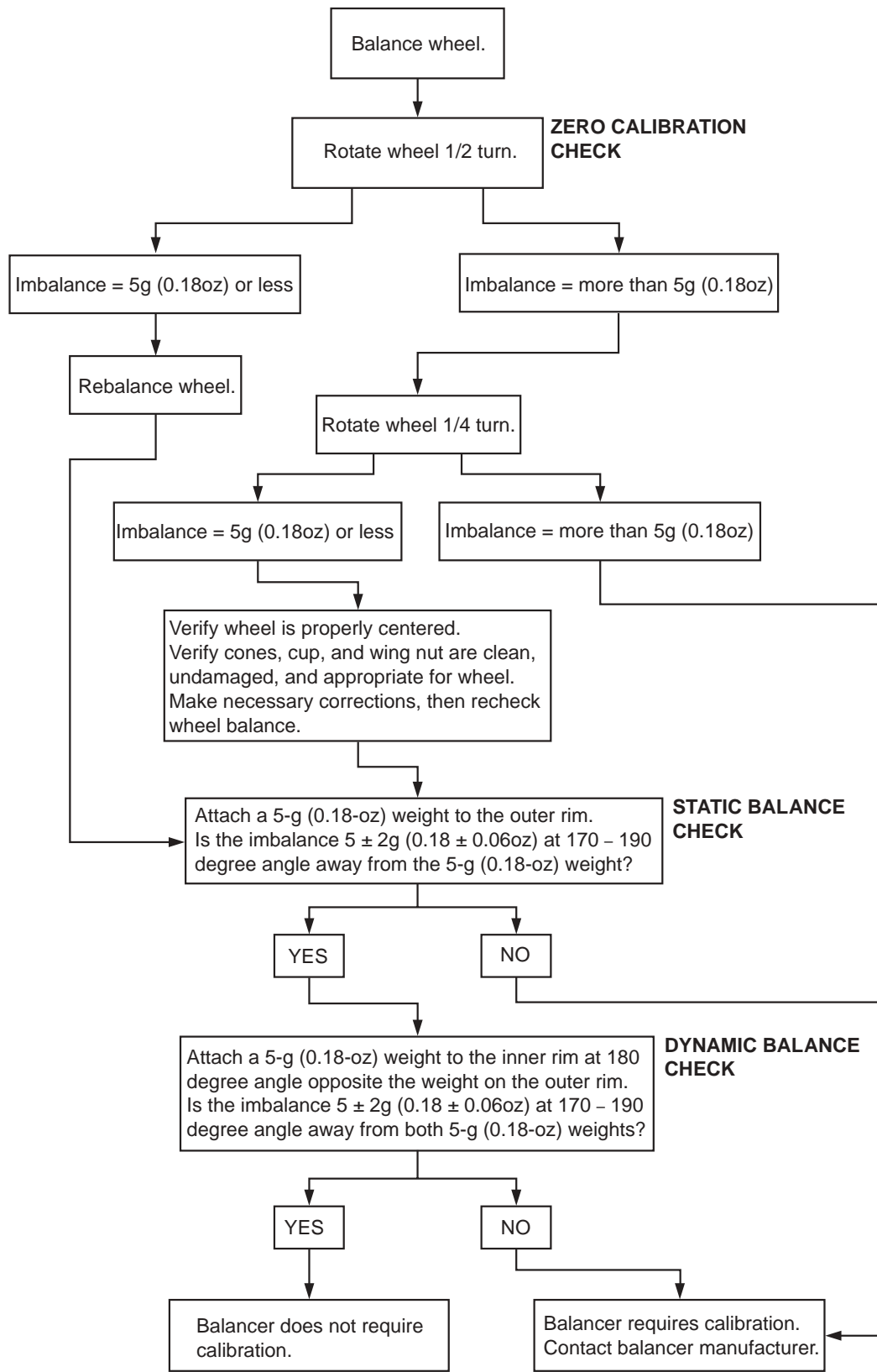

AC000040

ON-VEHICLE SERVICE**TIRE INFLATION PRESSURE CHECK**

M1311000900271

NOTE: For information on tire inflation pressure, refer to the label attached to the center pillar on the driver's side.

TIRE WEAR CHECK

M1311001000282

Measure the tread depth of the tires.

Minimum limit: 1.6 mm (0.06 inch)

If the remaining tread depth is less than the minimum limit, replace the tire.

NOTE: When the tread depth of the tires is reduced to 1.6 mm (0.06 inch) or less, wear indicators will appear.

WHEEL RUNOUT CHECK

M1311001100308

Jack up the vehicle so that the wheels are clear of the floor. While slowly turning the wheel, measure wheel runout with a dial indicator.

Limit:

Radial runout; 1.0 mm (0.04 inch) or less

Lateral runout; 1.0 mm (0.04 inch) or less

If wheel runout exceeds the limit, replace the wheel.

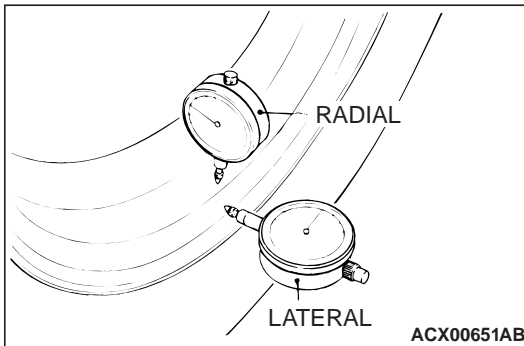
**WHEEL AND TIRE****INSTALLATION SERVICE POINT**

M1311001300249

Tighten the wheel nuts to the specified torque.

Tightening torque: 98 ± 10 N·m (73 ± 7 ft-lb)

SPECIFICATIONS

FASTENER TIGHTENING SPECIFICATION

M1311001600284

ITEM	SPECIFICATION
Wheel nut	98 ± 10 N·m (73 ± 7 ft·lb)

GENERAL SPECIFICATIONS

M1311000200302

ITEM	SPECIFICATION	SPECIFICATION
Wheel	Type	Aluminum type
	Size	17 × 8JJ
	Amount of wheel offset mm (in)	38 (1.5)
	Pitch circle diameter (PCD) mm (in)	114.3 (4.50)
Tire	Size	P235/45R17 93W
Spare wheel	Type	Steel type
	Size	17 × 4T
	Amount of wheel offset mm (in)	30 (1.2)
	Pitch circle diameter (PCD) mm (in)	114.3 (4.50)
Spare tire	Size	T125/70D17 98M

NOTE: PCD (Pitch Circle Diameter) indicates the pitch circle diameter of the wheel installation holes.

SERVICE SPECIFICATIONS

M1311000300343

ITEMS	LIMIT
Tread depth of tire mm (in)	Minimum 1.6 (0.06)
Wheel runout (Radial runout) mm (in)	1.0 (0.04) or less
Wheel runout (Lateral runout) mm (in)	1.0 (0.04) or less

NOTES