

GROUP 54A

CHASSIS ELECTRICAL

CONTENTS

GENERAL DESCRIPTION.....	54A-2	LIGHTING	54A-5
DIAGNOSIS SYSTEM	54A-2	COMBINATION METER.....	54A-8
BATTERY.....	54A-3	RADIO, CD PLAYER, SPEAKER, ANTENNA.....	54A-8
IMMOBILIZER SYSTEM	54A-4		

GENERAL DESCRIPTION

M2540000100142

FEATURES

1. Waterproof connectors are used in the engine compartment.
2. A relay box is used.
3. Discharge headlights are used for the low-beam headlights.
4. Fog lights are incorporated in to headlight assembly.
5. A high mount stop light is used.
6. A large combination meter with analog indicators is used.
7. Position light indicator is used in the combination meter.
8. An immobilizer system is provided.

Improvements in service quality

1. Data link connectors (2 pieces) for inspection with MUT-II/III are provided.

DIAGNOSIS SYSTEM

M25400001000137

For improved serviceability, a data link connector for inspection with MUT-II/III is built into the instrument panel near the position of the driver's left foot.

DIAGNOSIS FUNCTION	MFI	ABS	IMMOBILIZER	SRS	ETACS
DTC code sent	×	×	×	×	×
Service data sent	×	×	—	×	—
Actuator test	×	×	—	—	—
DTC code sent by warning light	—	×	—	—	—
Diagnosis record stored	×	×	×	×	×
Diagnosis deletion using MUT-II/III	×	×	×	×	×
Pulse check using MUT-II/III	—	—	—	—	×

DATA LINK CONNECTOR

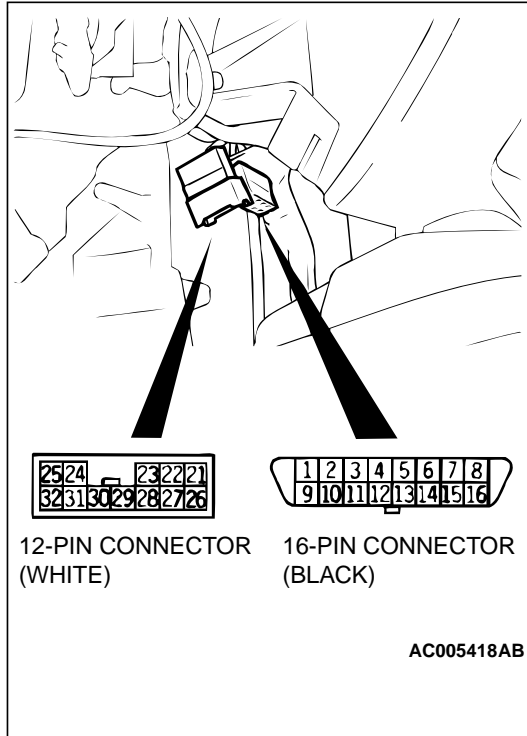

DATA LINK CONNECTOR (BLACK)	
1	Diagnosis control
2, 3	–
4	Grounding
5	Grounding
6	–
7	MFI, ABS, SRS
8	–
9	ETACS-ECU
10	–
11	–
12	–
13	–
14	Simulated vehicle speed signal
15	–
16	Battery

DATA LINK CONNECTOR (WHITE)	
21 – 25	–
26	MFI
27 – 32	–

BATTERY

M2540002000129

A lightweight and compact battery is provided.

ITEM	75D23L
Voltage V	12
Capacity (5 hours average Ah)	53
Specific gravity of battery electrolyte (fully charged at 20 °C)	1.280

IMMOBILIZER SYSTEM

M2540003000069

The engine immobilizer system prevents the engine from starting and immobilizes the vehicle if a key other than the key registered for that vehicle is used in an attempt to start the engine after forced entry. The engine immobilizer system consists of the ignition key, key ring antenna, immobilizer ECU, and engine control module (ECM). It works in the following way and has these functions:

1. After the ignition is switched on, the engine control module sends a control signal and transponder read command signal to the immobilizer ECU.
2. When the immobilizer ECU receives the control signal from the engine control module through the key ring antenna, the immobilizer ECU supplies a current and sends random number data to the transponder in the ignition key.
3. The transponder uses the random number data to derive an ID code, which is sent to the immobilizer ECU through the key ring antenna.
4. The immobilizer ECU compares the ID code that was sent with pre-registered ID codes, and if it matches, a control signal approving ignition is sent to the engine control module. If the ID code does not match (in the case of counterfeit ignition keys, for example), the immobilizer ECU sends a control signal denying ignition to the engine control module, preventing the engine from starting.
5. The system is designed to be maintenance-free because the power source for the transponder is supplied by the immobilizer ECU. Two ignition keys are provided, and up to four keys can be registered to one vehicle (one receiver) as needed. There are one million possible combinations for the registered ID codes. In addition, one part of the code is changed each time the key is switched on, which improves security by preventing theft using a copied ID code.

NOTE: If the immobilizer ECU is replaced or if the ignition key is lost or additional keys are requested, the MUT-II or III must be used to reset all transmitter ID codes. During the resetting process, all transmitters must be re-registered because the registered ID codes will be erased.

CONSTRUCTION DIAGRAM

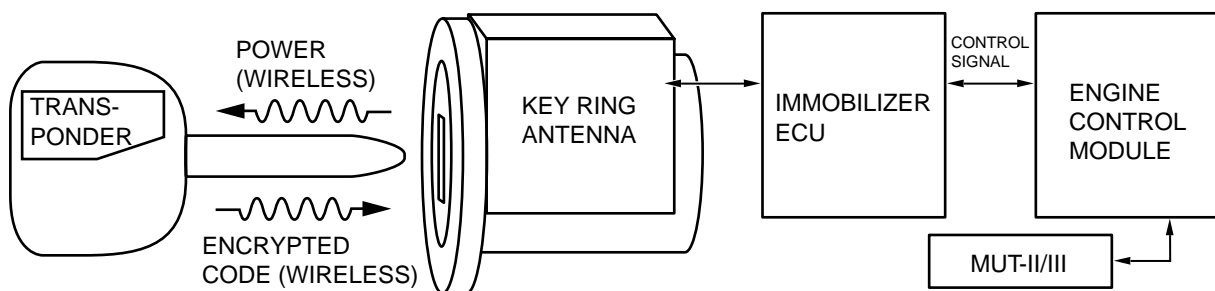

AC210964AB

LIGHTING

M2540004000192

EXTERIOR LIGHTS

HEADLIGHT ASSEMBLY

- A high intensity discharge (HID) headlight is provided for low-beam headlight, so that visibility is greatly improved compared with usual halogen headlight. In structure and operation, refer to .
- The front turn-signal light, position light and fog light are integrated in a single unit for four bulb type headlight.

REAR COMBINATION LIGHT

- A rear combination light is exclusive for EVOLUTION.

HIGH MOUNT STOP LIGHT

- A high mount stop light is installed to the rear shelf.

ITEM		SPECIFICATIONS
Headlight assembly W	High-beam W (halogen bulb)	60 (HB3)
	Low-beam W (discharge bulb)	35 (D2S)
	Fog light W	51 (HB4)
	Position light W	5
	Front turn-signal light W	21
Side turn-signal light W		21
Rear combination light W	Tail W	5
	Tail/stop W	5/21
	Turn-signal W	21
	Back-up W	21
High mount stop light W		21
License plate light W x number		5 × 2

NOTE: The brackets () show the bulb type.

CONSTRUCTION DIAGRAM

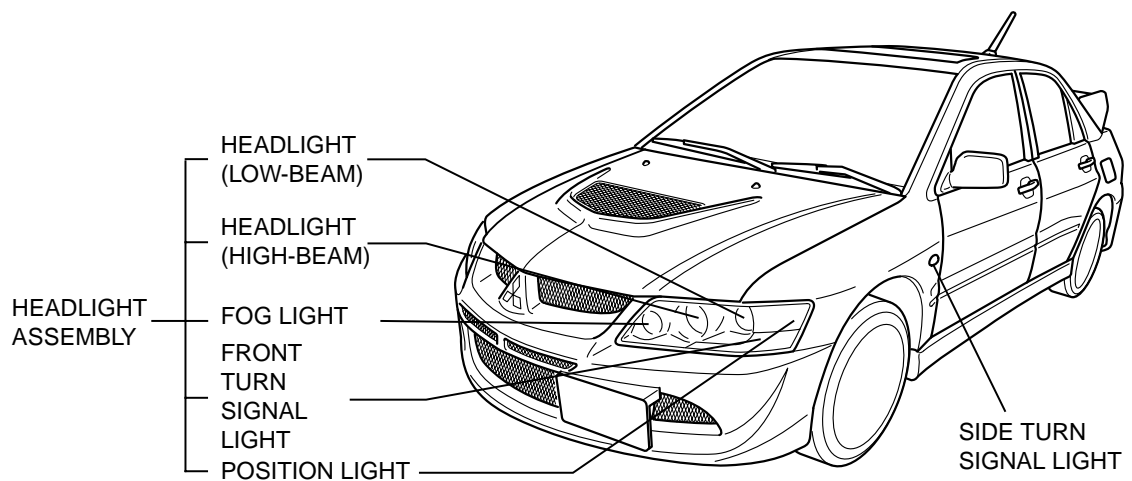

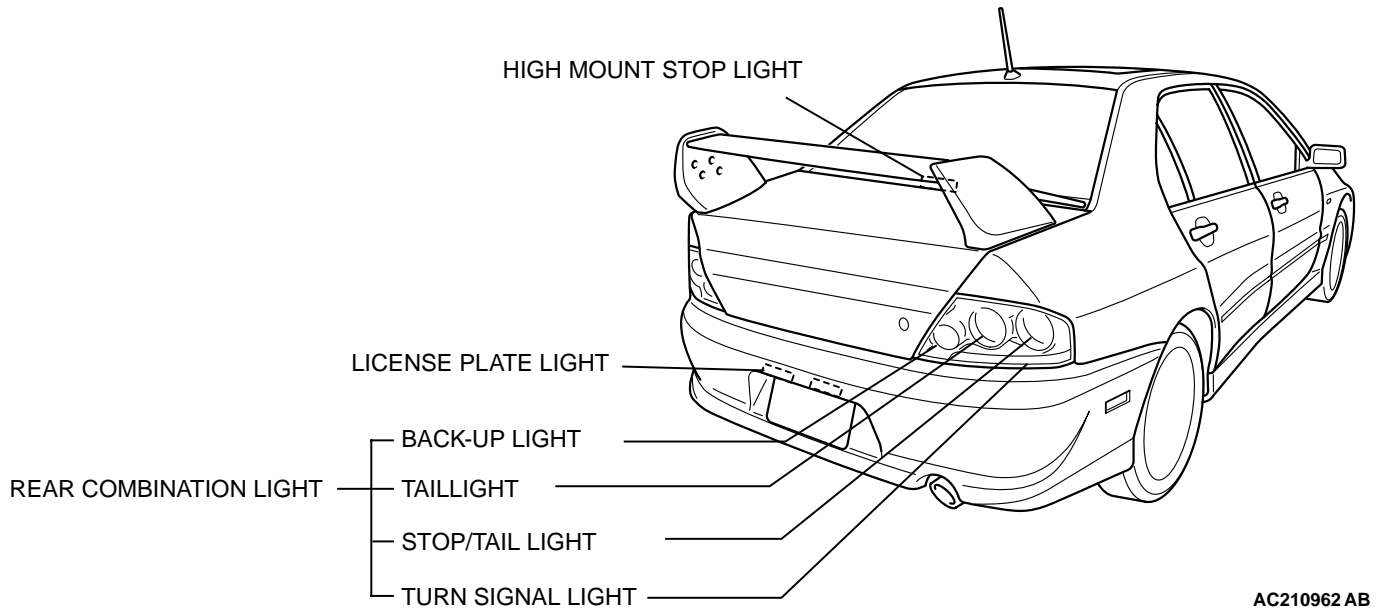

DESCRIPTION OF STRUCTURE AND OPERATION FOR HID HEADLIGHT

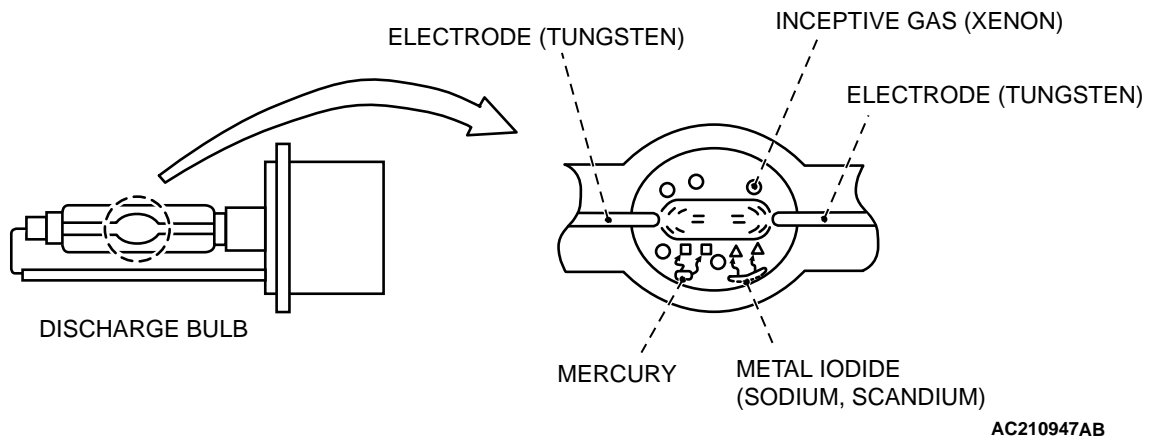

The HID headlight consists of the discharge bulb and controller that changes battery power supply into high-voltage AC.

INTERIOR LIGHTS

- A map light serving also as front dome light can be used at both the driver's seat and passenger seat..
- A rear dome light illuminates the back seat. A trunk light illuminates the trunk.

SPECIFICATIONS

ITEM		SPECIFICATIONS
Map light and front dome light	Map light W × quantity	7.5 × 2
	Front dome light W	7.5
Rear dome light W		8
Trunk light W		5

CONSTRUCTION DIAGRAM

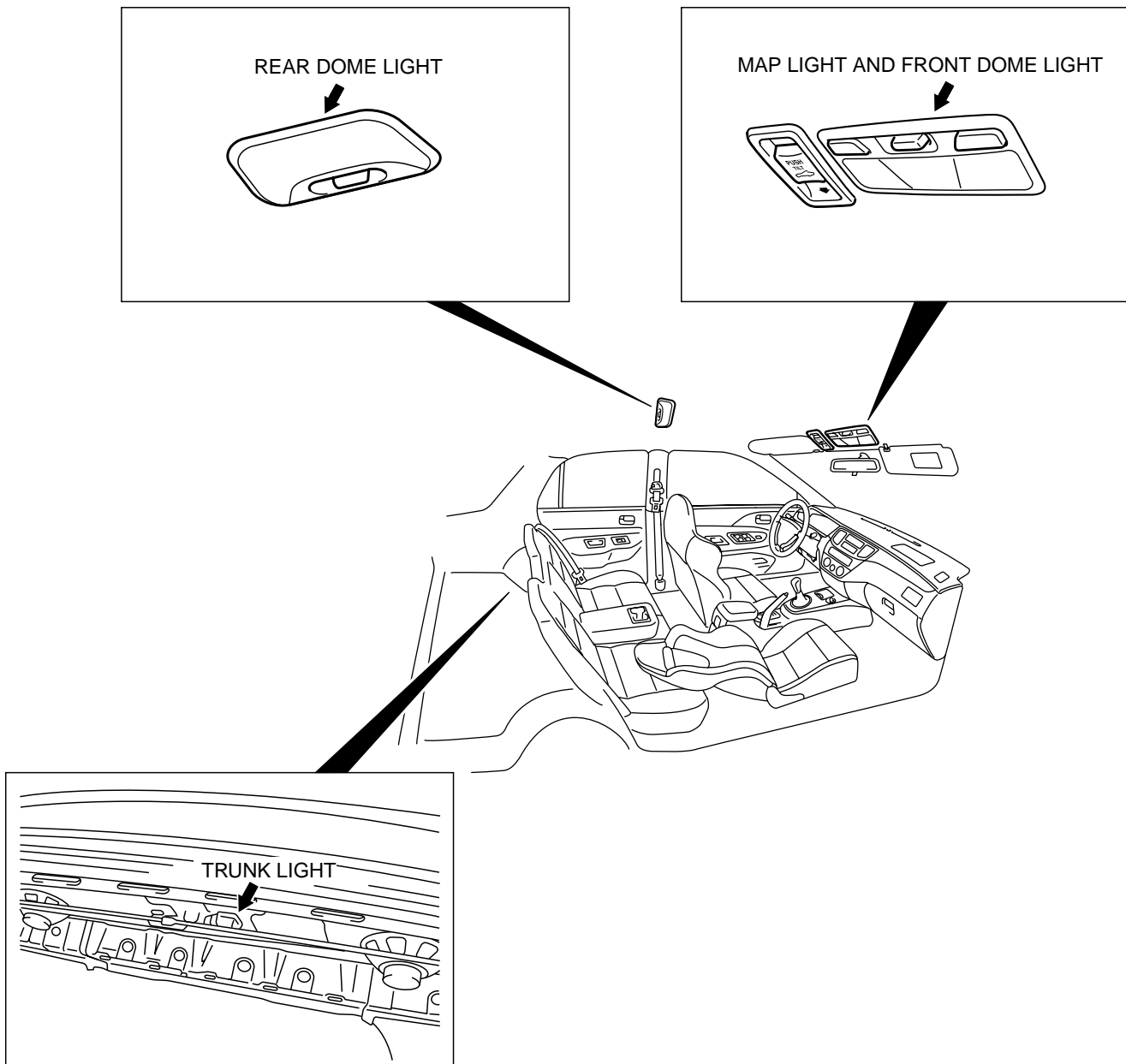

COMBINATION METER

M2540005000151

The combination meter features large, clearly visible analog gauges. The gauges are arranged with the tachometer in the middle, the speedometer at left, and the fuel and coolant temperature gauges and indicator lamps at right.

- The speedometer is an electronic type speedometer which operates by the pulse signal generated by the speed sensor.

- A large, clear LCD type odo-tripmeter is provided. The odometer continuously displays values while the tripmeter has a twin-trip (trip A, trip B) function which is switched by a reset button.
- The fuel gauge has a triangular mark indicating the location of the fuel filler door on the left side of the vehicle.
- A position light indicator is provided to show clearly the taillight lighting condition.

CONSTRUCTION DIAGRAM

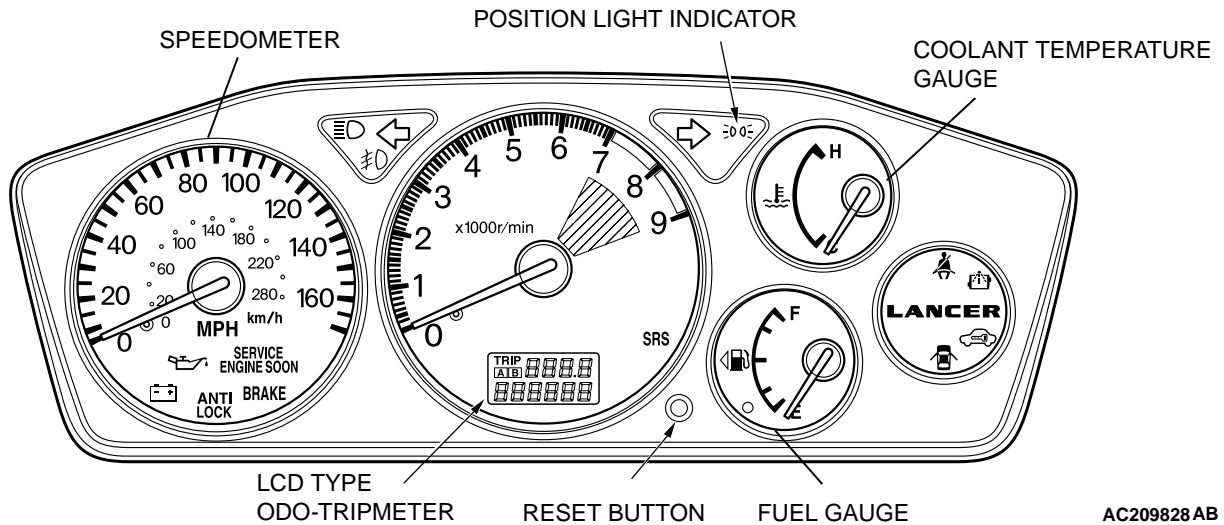

AC209828 AB

RADIO, CD PLAYER, SPEAKER, ANTENNA

M2540006000143

RADIO AND CD PLAYER

Two types of 1 DIN size integrated audio units are provided for the radio and tape player.

ITEM	AUDIO
AM/FM electronic tuning radio	Equipped
CD player	Equipped
CD auto-changer (6-disk pack player)	Equipped (Option)
Power amplifier with radio	35 W × 4

SPEAKER

Six speakers (front door: 16 cm, rear shelf: 16 cm, tweeter: 3.5 cm) are provided. The speaker is a dual cone full range speaker.

ANTENNA

A roof whip antenna is provided.

CONSTRUCTION DIAGRAM

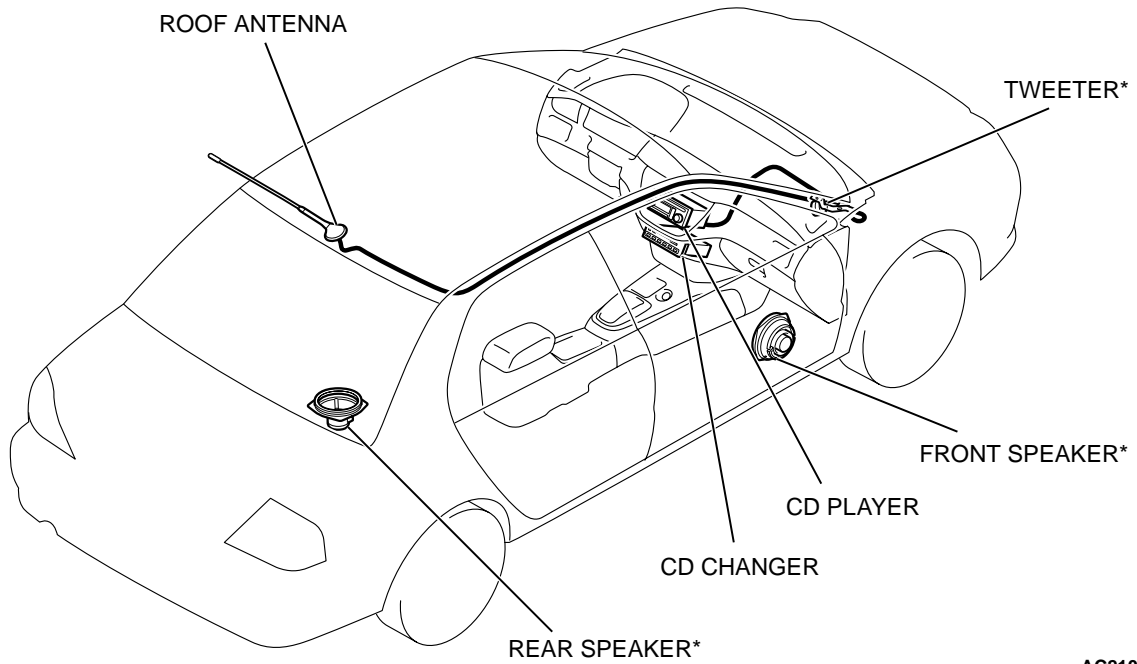

AC210965 AB

NOTE: The * indicates equipped on the left and right sides.

<RADIO AND CD CHANGER>

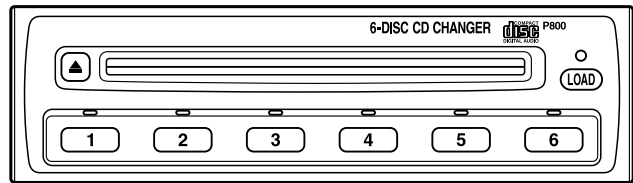
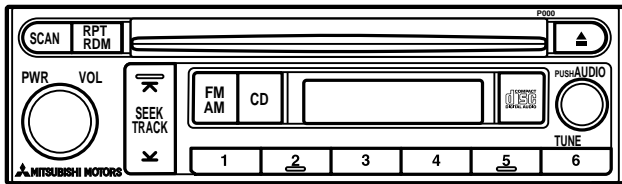

AC211337 AB

NOTES